



UBTECH ROBOTICS CORP COMPANY PROFILE



UBTECH – A GLOBAL LEADER IN INTELLIGENT SERVICE ROBOT INDUSTRY

A high-tech enterprise engaging in the R&D, manufacture, as well as promoting and popularizing robots around the world

The first company in China dedicated to commercializing humanoid robots

Invested into humanoid robots research in 2008 and established in 2012

Headquarters is located in Shenzhen, China and has branch office in USA

OUR MISSION, VISION & VALUES

MISSION

- Bring robots into every home, and truly integrate intelligent robots into the daily life of everyone, creating a more intelligent and human-friendly way of leisure life.

VISION

- To grow our leadership in intelligent service robot industry

VALUE

- Cooperation, Respect, Quality, Innovation

OUR MILESTONES

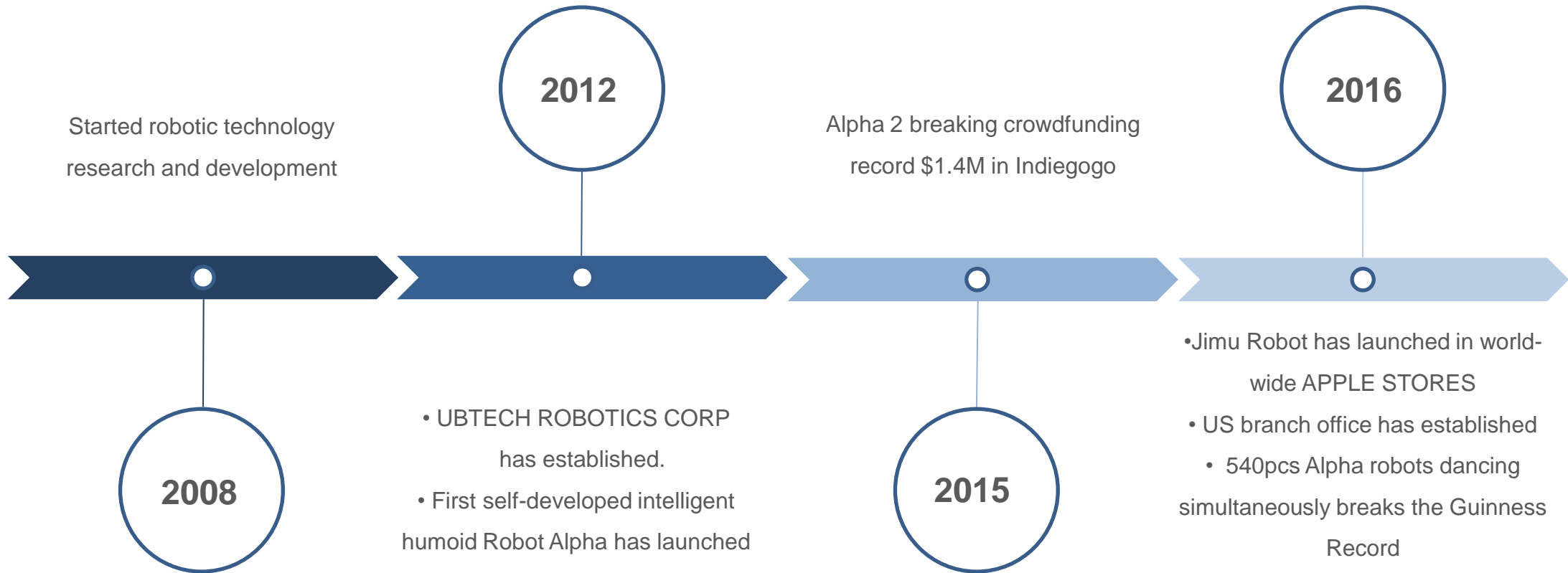

OUR TEAM



James Zhou
Founder & CEO

A pioneer of humanoid robotics, a dedicated expert who's devoted his career to creating intelligent robots for family use

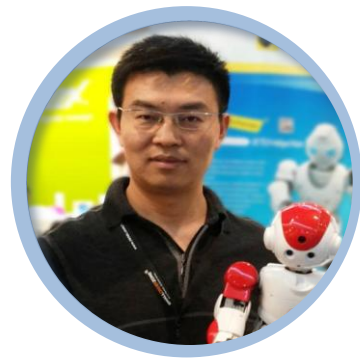

Dr. Rick Xiong
CTO

A legend of robotic R&D, having won eight international championships in robotics-related competitions



Warren Wang
COO

19 years experience in CE industry, achieved great success in cooperated operation and international marketing

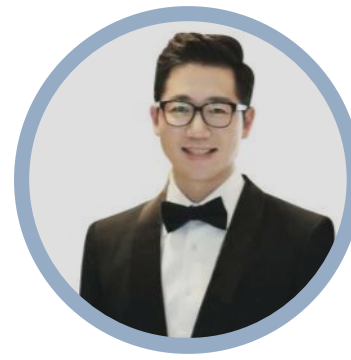

John Rhee
GM-North America

15 years of branding and marketing with experience of start-ups in gaming and consumer electronics



Andy Zhang
Vice President

Extensive experience at project management, cooperated operations, retail channels and integration of new media dissemination

OUR ADVANTAGES

A global leading commercialized humanoid service robots company

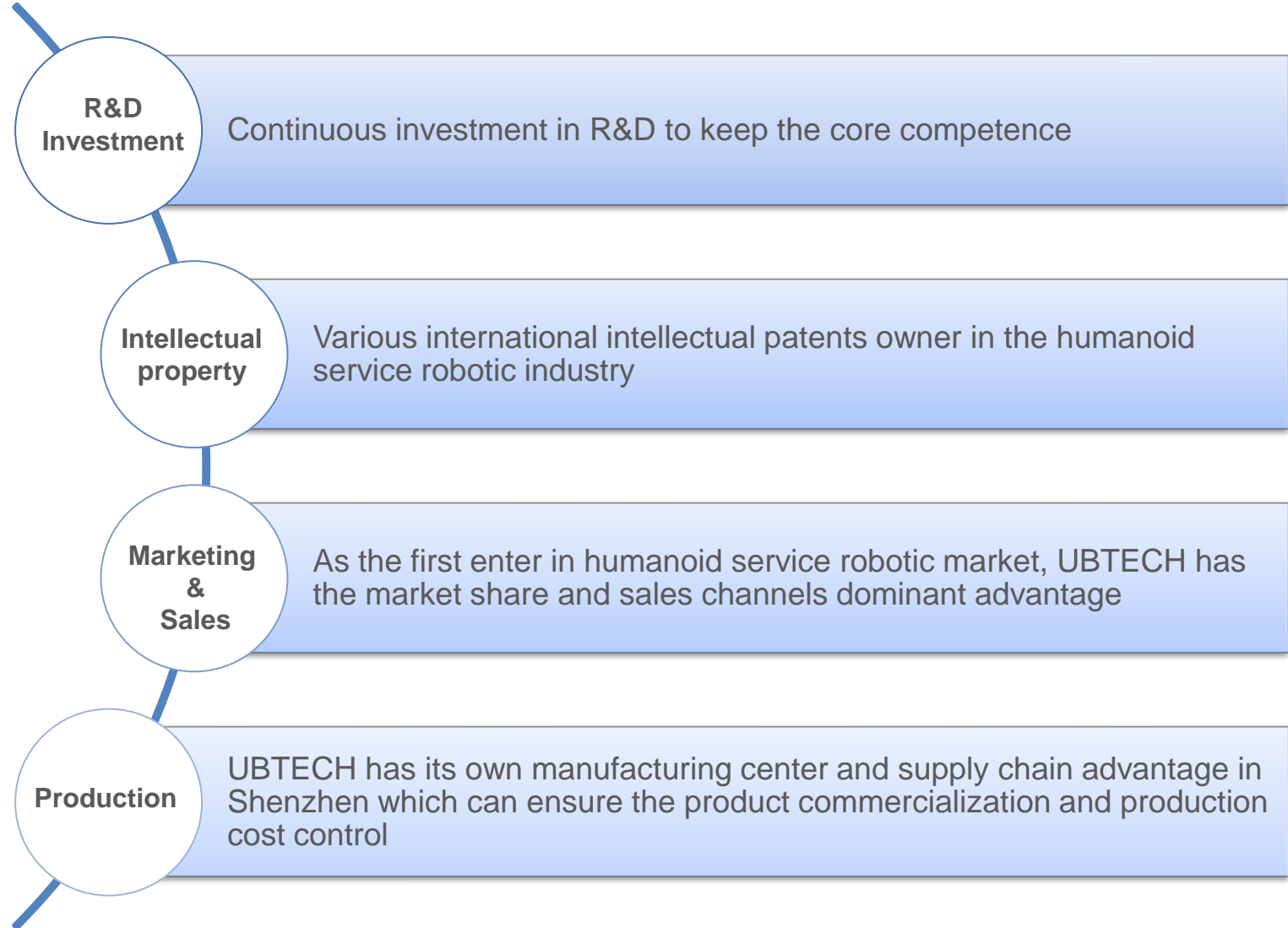



Sales Network

Global sales network, products are available in various stores in the US, EU, Japan and many other countries.



Global Sites

HQ is located in Shenzhen – Silicon Valley of China, and has branch office in Los Angeles, USA.



International Marketing

UBTECH continues to expand in global markets and actively participates in various international exhibitions and trade fairs such as IFA, CES etc.

Global Sales Network



Patents & Certificates



Dedicated to robotic hardware and software technology development with a top robotic engineering team.

Owns the most intellectual patents in the humanoid service robotic industry, including invention patents, industrial design patents, practical patents etc.



UBTECH PRODUCTS

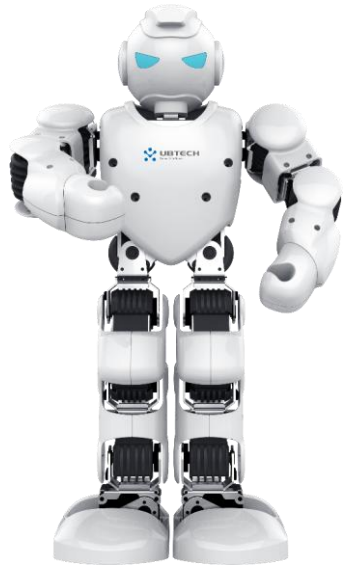

Alpha1 Pro

The First Humanoid Robot
Designed for the Family

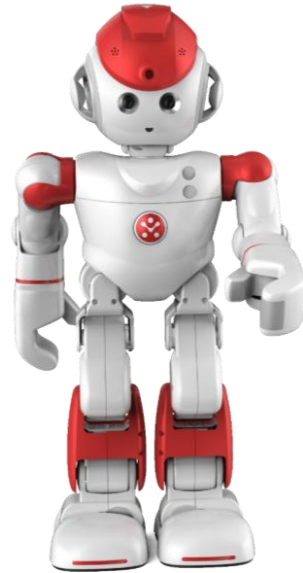

Alpha 2

The Most Intelligent Household
Humanoid Robot



Jimu Robot

The Interactive System of
Robotic Building Blocks



Cruiser

Bipedal Robot
(Under Development)



**Robotic Servo
Motor**

Power the Robot

Robotic Servo Motor

POWER YOUR ROBOT!

Large Torque

High Accuracy

Small Size

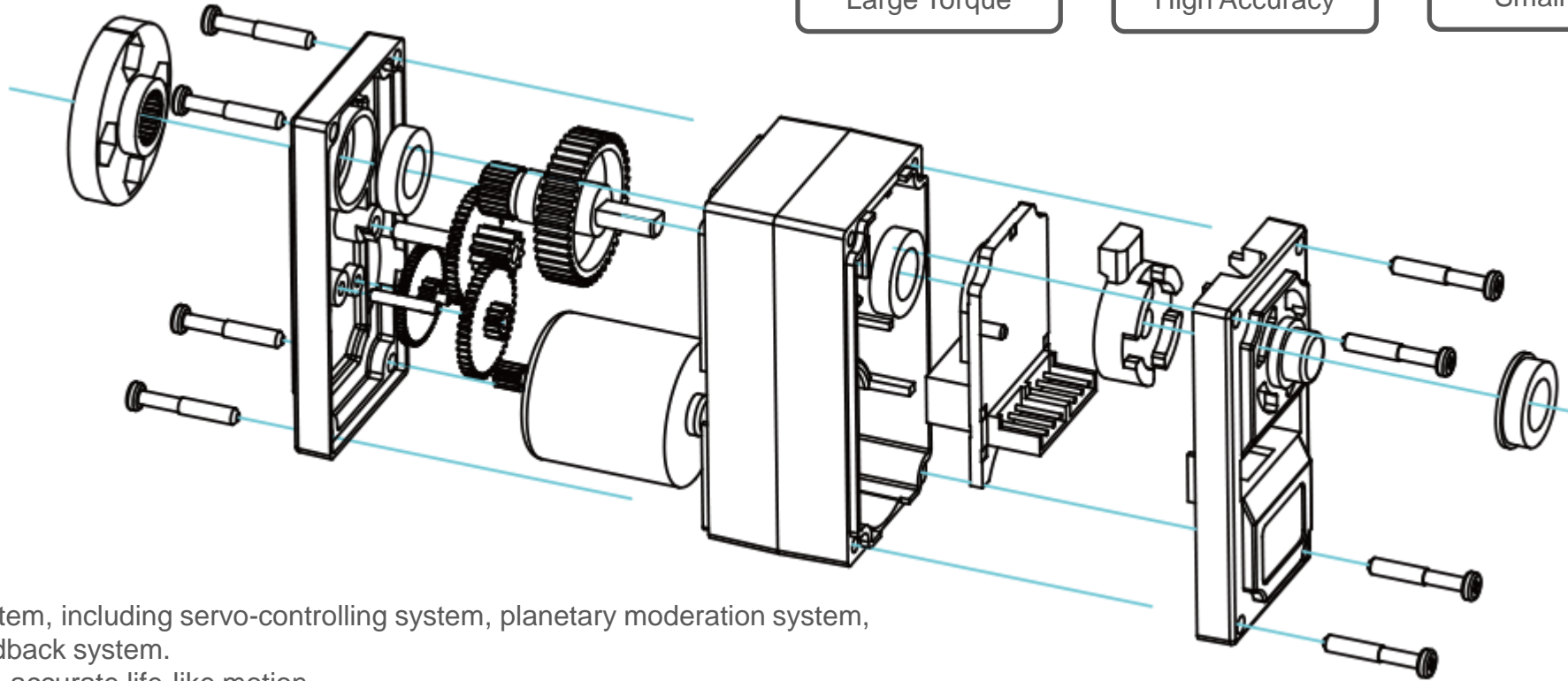

Built-in MCU system, including servo-controlling system, planetary moderation system, and sensory feedback system.
Produce smooth, accurate life-like motion.
Easily integrate with connectors and character parts



Alpha1 Pro

UBTECH ROBOTICS

Alpha1 Pro

The Fun Family Robot

Programmable, Educational, Entertaining

16 patented servos, extremely flexible and can move just like a human

3D visual PC software support complete beginners and advanced programmer

Mobile APP control (iOS & Android devices) connected via high speed Bluetooth

PRP (Pose, Record and Playback) function, program the robot by adjusting its pose manually, and make the robot memorize each pose autonomously



ALPHA1 PRO 3D Visual Program Software

Programming software for 3D visual actions with an interface that is simple and easy to operate. This enables even non-professionals to program in no time.

Compatible with Windows and Mac OS systems.



From complete beginners to advanced programmers, this 3D software can help you program your Alpha 1 PRO easily!

PRP (Pose, Record and Playback) Function



Pose



Record



Playback

Versatility, Sharing the Happiness



- Intuitive Programming, Intelligence Developer
- Actions Download, Creativity Sharing
- New Communication, Smart Interaction



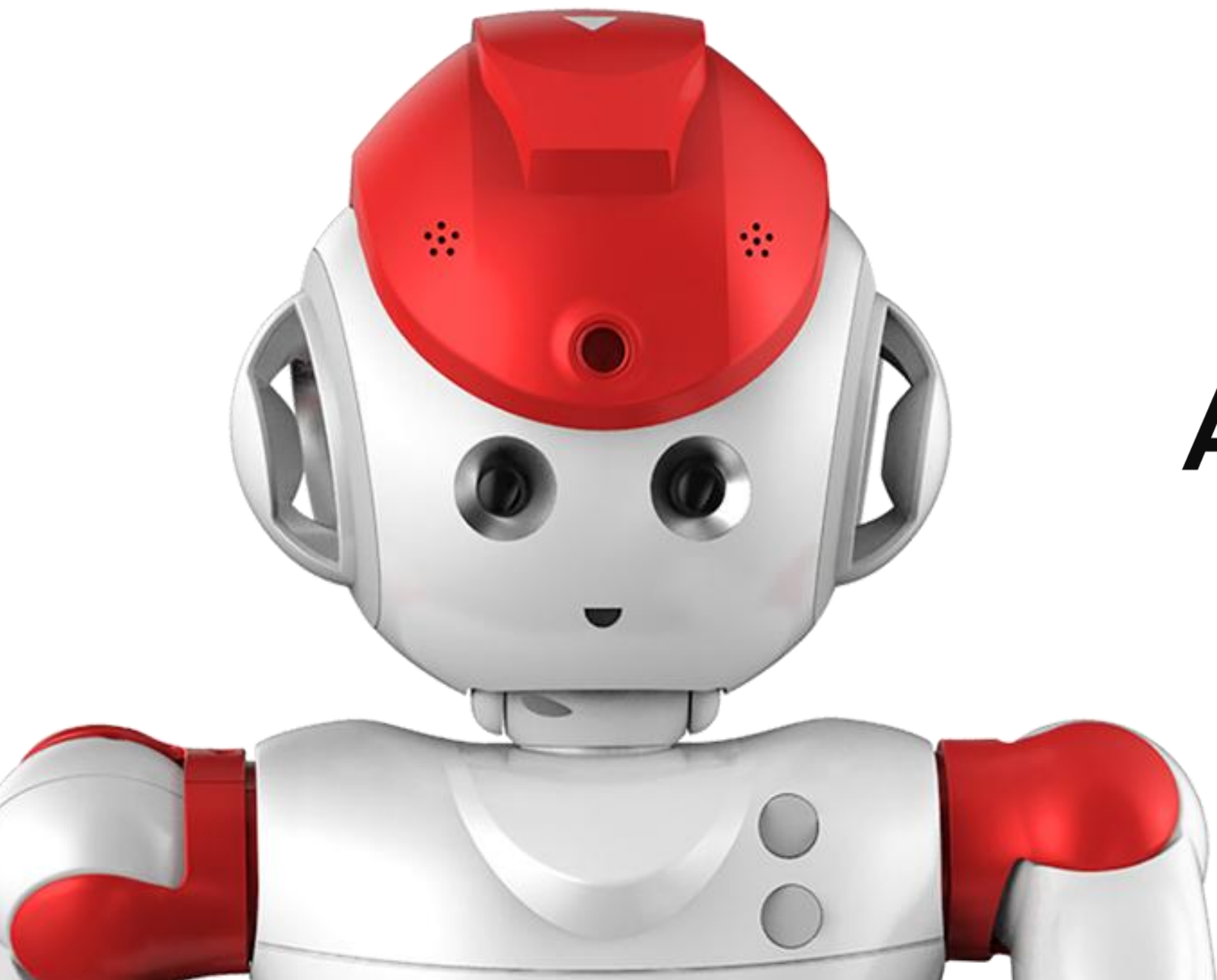

ALPHA 2

UBTECH ROBOTICS

Alpha 2

Your New Family Member

Intelligent. Interactive. Expandable

Built-in ultrasonic sensor, touch sensor, acceleration sensor

Offering a brand new kind of interaction between human and computer

2G memory & six-core processor

Power intelligent computing performance and smoother operation

8 Mega-pixel camera

Built-in intelligent voice system

VAPP: voice control application

Cloud based **VAPP Store & developers' community**



What can Alpha 2 do?

20 joints
replicate human
movement

As flexible as a yogi





Reminders & Alarms

Reminder & Alarm



Simultaneous Interpretation

Simultaneous Interpretation



Local-based Weather Forecast

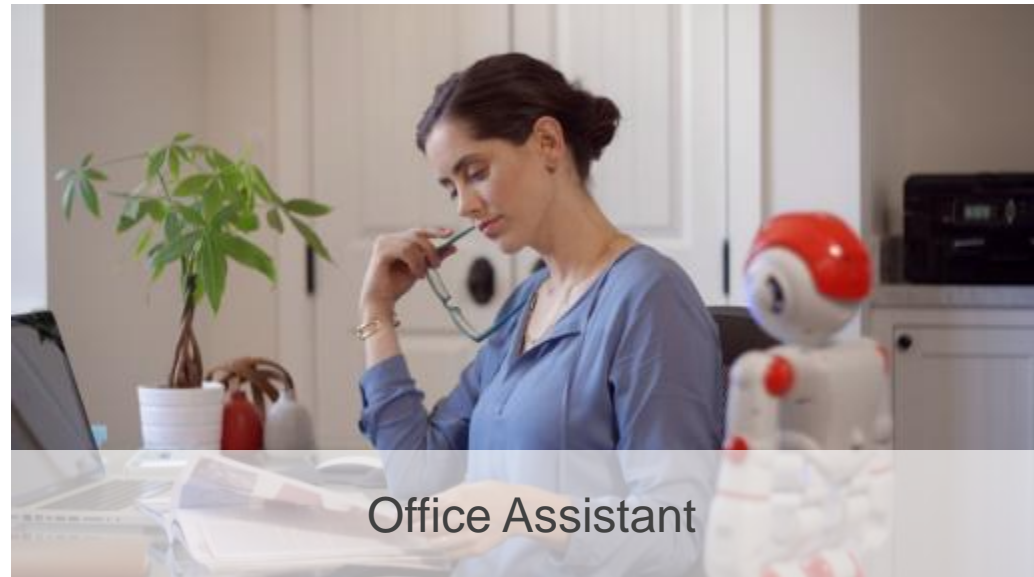

Office Assistant



Voice Control Music/FM Radio

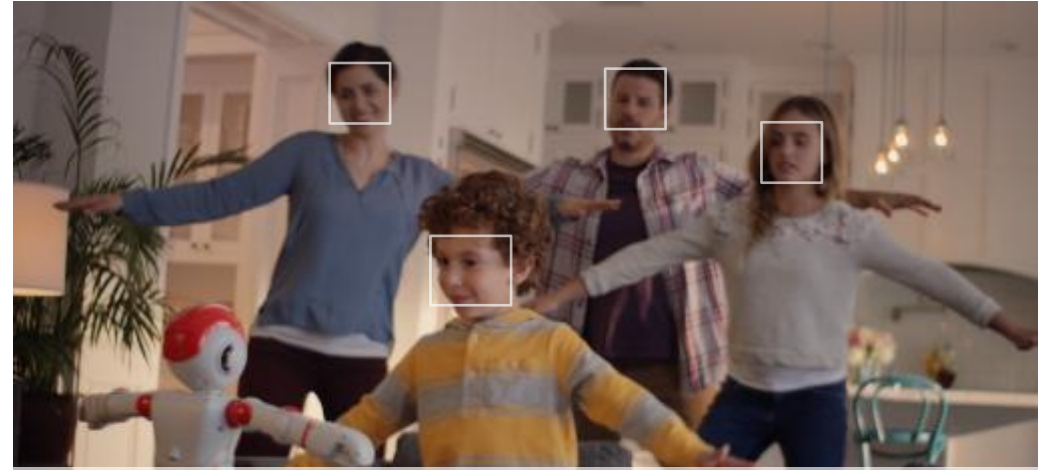

Hands Free Photos & Videos

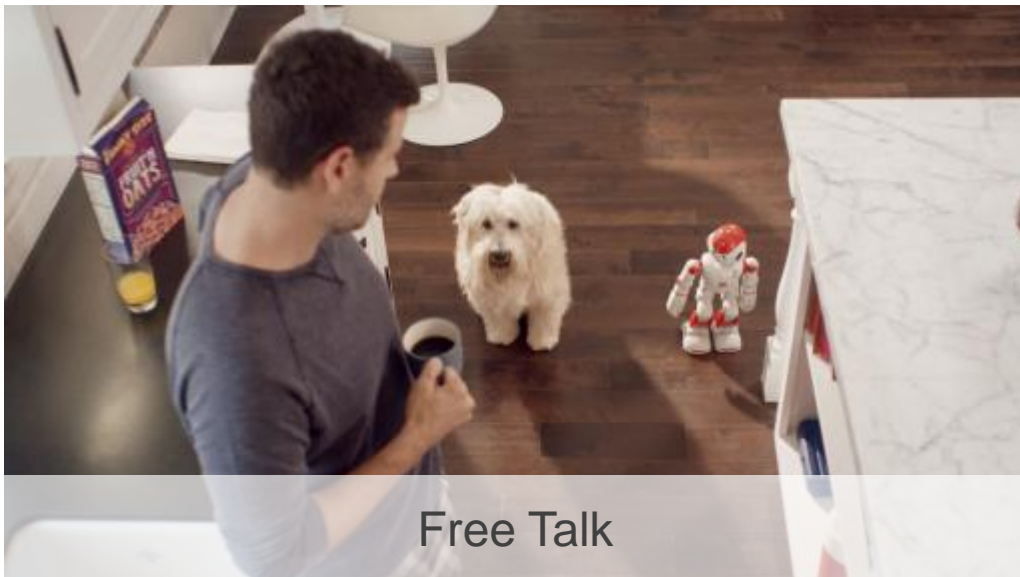

Free Talk



Storyteller



Alpha 2 VAPP Store & Developer Community





-
- An interactive system of robotic building blocks
 - STEM-driven, interactive play featuring mechanical engineering and robotic programming
-



Jimu Robot

Make Your Imagination Move!

Build. Program. Share

Build your robot

- Directed play for specific, pre-designed robots
- Open-ended play to create whatever you can imagine

Program your robot's movements

- Pre-set movements and controls to play with immediately
- Easily programmable with the app to make your robot move however you like

Share your creation with the Jimu Community

- Easy to upload & share your creation, and like others' creations



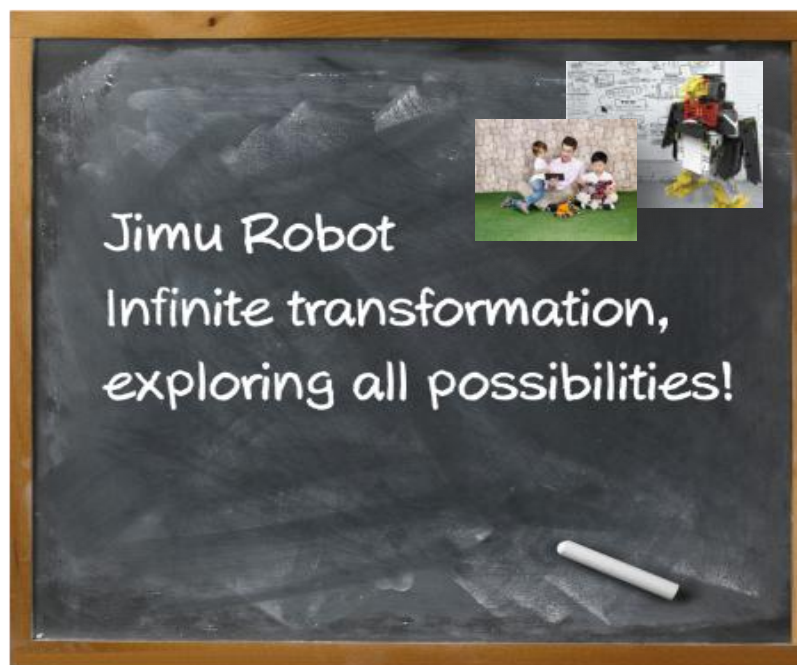
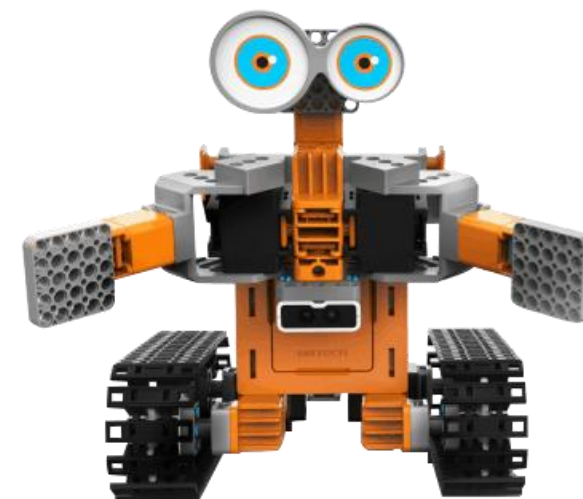

Jimu Robot Available Kits

KARBOT KIT		×	3	
MINI KIT		×	4	
EXPLORER KIT		×	7	
INVENTOR KIT		×	16	

Jimu Robot Available Kits



MEEBOT KIT



ANIMAL ADD-ON KIT

Launch in World-wide Apple Stores in July, 2016



Jimu Robot App Store & Jimu Community



Jimu Robot is a great way to engage kids in STEAM curriculum.

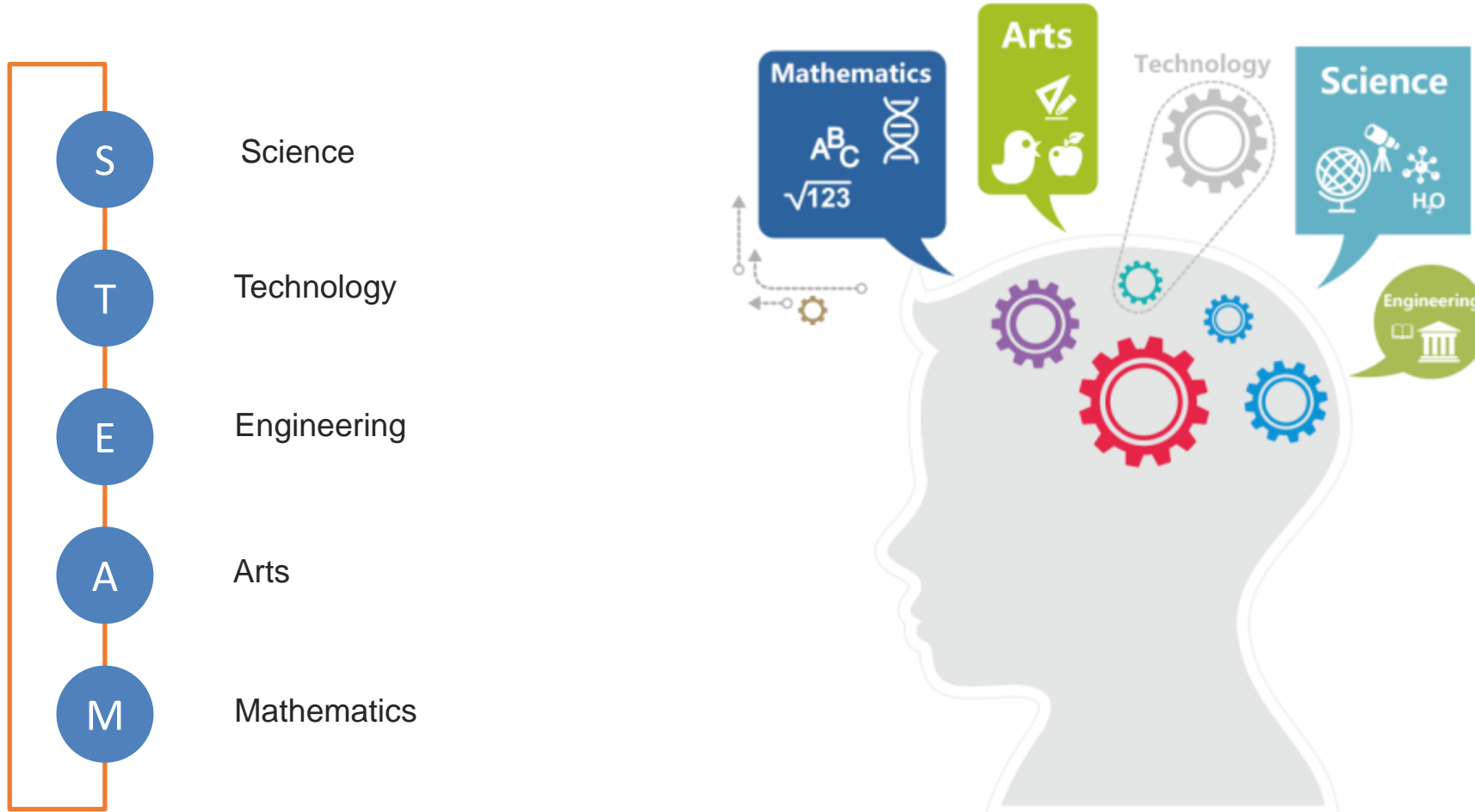

Cruiser

Bipedal Service Robot
(Under development)

The first commercialized bipedal humanoid service robot in the world



BRAND EXPOSURE

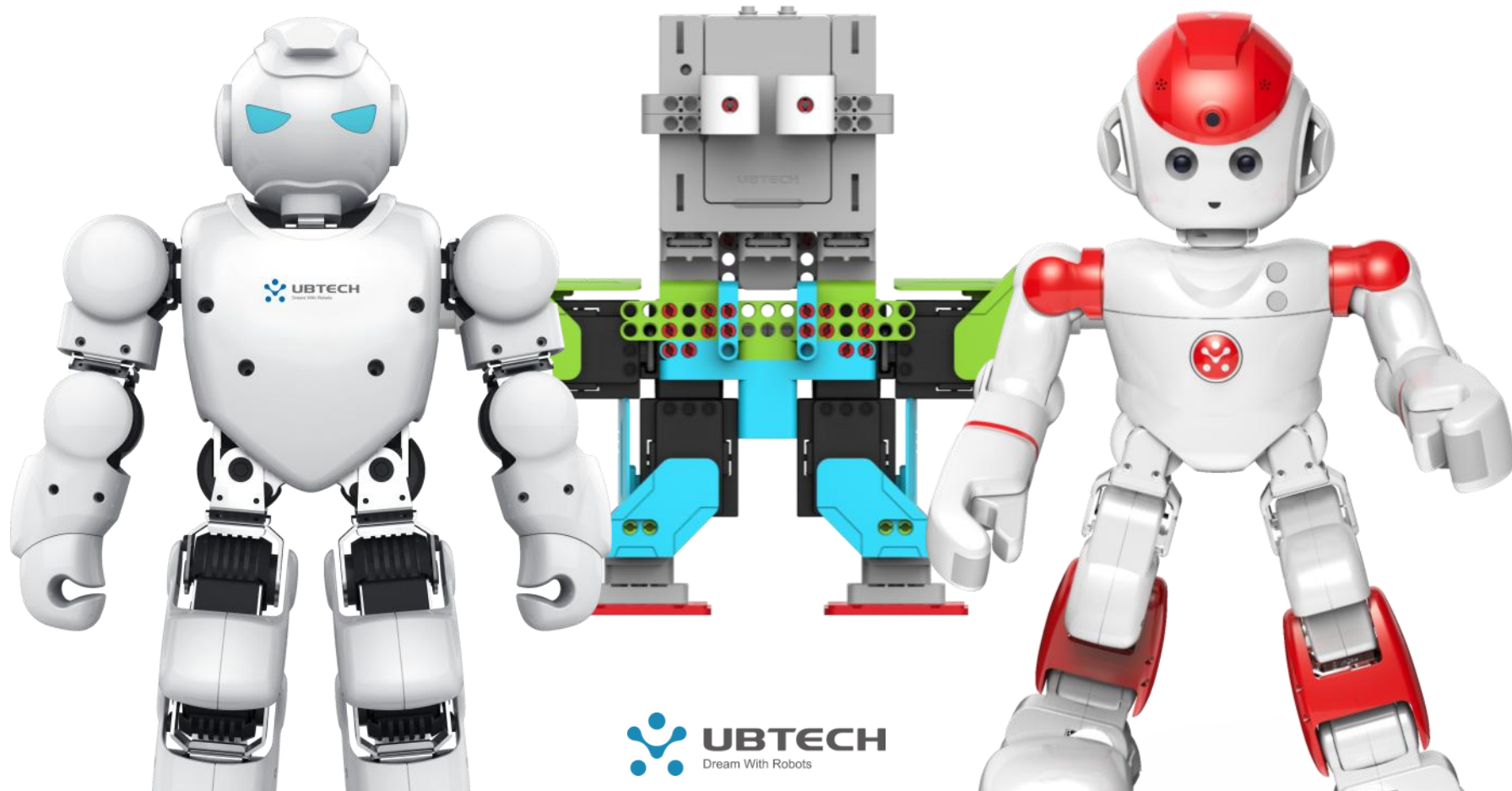

**540pcs Alpha Robots Dancing Simutaneously
GUINNESS WORLD RECORDS IN MAY 2016**



Brand Exposure in the United States and Europe



Star of 2016 China CCTV Spring Festival and Lantern Festival Gala



2016 Rio Olympics Exposure on CCTV



2016 Apple x Jimu Launch Event in Beijing Apple Store



2016 Apple x Jimu Launch Event in Shanghai Apple Store



International Exhibitions

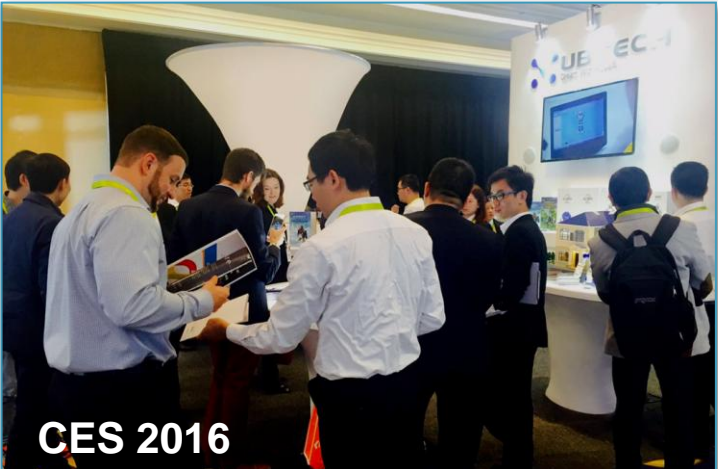
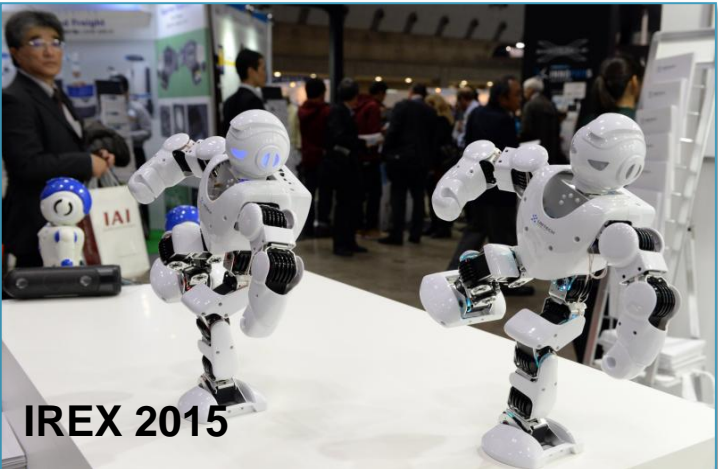



Dream with Robots
Bring the humanoid robot into every family





UBTECH

Dream With Robots

Thank You!